

User Manual and Installation Guide

Portable Pole Metal Detector MDS100

Date: March 2022

Doc Version: 1.0

English

Thank you for choosing our product. Please read the instructions carefully before operation. Follow these instructions to ensure that the product is functioning properly. The images shown in this manual are for illustrative purposes only.



For further details, please visit our Company's website www.zkteco.com.

Copyright © 2022 ZKTECO CO., LTD. All rights reserved.

Without the prior written consent of ZKTeco, no portion of this manual can be copied or forwarded in any way or form. All parts of this manual belong to ZKTeco and its subsidiaries (hereinafter the "Company" or "ZKTeco").

Trademark

ZKTeco is a registered trademark of ZKTeco. Other trademarks involved in this manual are owned by their respective owners.

Disclaimer

This manual contains information on the operation and maintenance of the ZKTeco equipment. The copyright in all the documents, drawings, etc. in relation to the ZKTeco supplied equipment vests in and is the property of ZKTeco. The contents hereof should not be used or shared by the receiver with any third party without express written permission of ZKTeco.

The contents of this manual must be read as a whole before starting the operation and maintenance of the supplied equipment. If any of the content(s) of the manual seems unclear or incomplete, please contact ZKTeco before starting the operation and maintenance of the said equipment.

It is an essential pre-requisite for the satisfactory operation and maintenance that the operating and maintenance personnel are fully familiar with the design and that the said personnel have received thorough training in operating and maintaining the machine/unit/equipment. It is further essential for the safe operation of the machine/unit/equipment that personnel has read, understood and followed the safety instructions contained in the manual.

In case of any conflict between terms and conditions of this manual and the contract specifications, drawings, instruction sheets or any other contract-related documents,

the contract conditions/documents shall prevail. The contract specific conditions/documents shall apply in priority.

ZKTeco offers no warranty, guarantee or representation regarding the completeness of any information contained in this manual or any of the amendments made thereto. ZKTeco does not extend the warranty of any kind, including, without limitation, any warranty of design, merchantability or fitness for a particular purpose.

ZKTeco does not assume responsibility for any errors or omissions in the information or documents which are referenced by or linked to this manual. The entire risk as to the results and performance obtained from using the information is assumed by the user.

ZKTeco in no event shall be liable to the user or any third party for any incidental, consequential, indirect, special, or exemplary damages, including, without limitation, loss of business, loss of profits, business interruption, loss of business information or any pecuniary loss, arising out of, in connection with, or relating to the use of the information contained in or referenced by this manual, even if ZKTeco has been advised of the possibility of such damages.

This manual and the information contained therein may include technical, other inaccuracies or typographical errors. ZKTeco periodically changes the information herein which will be incorporated into new additions/amendments to the manual. ZKTeco reserves the right to add, delete, amend or modify the information contained in the manual from time to time in the form of circulars, letters, notes, etc. for better operation and safety of the machine/unit/equipment. The said additions or amendments are meant for improvement /better operations of the machine/unit/equipment and such amendments shall not give any right to claim any compensation or damages under any circumstances.

ZKTeco shall in no way be responsible (i) in case the machine/unit/equipment malfunctions due to any non-compliance of the instructions contained in this manual (ii) in case of operation of the machine/unit/equipment beyond the rate limits (iii) in case of operation of the machine and equipment in conditions different from the prescribed conditions of the manual.

The product will be updated from time to time without prior notice. The latest operation procedures and relevant documents are available on <http://www.zkteco.com>

If there is any issue related to the product, please contact us.

ZKTeco Headquarters

Address ZKTeco Industrial Park, No. 32, Industrial Road,
Tangxia Town, Dongguan, China.

Phone +86 769 - 82109991

Fax +86 755 - 89602394

For business-related queries, please write to us at sales@zkteco.com.

To know more about our global branches, visit www.zkteco.com.

About the Company

ZKTeco is one of the world's largest manufacturers of RFID and Biometric (Fingerprint, Facial, and Finger-vein) readers. Product offerings include Access Control readers and panels, Near & Far-range Facial Recognition Cameras, Elevator/floor access controllers, Turnstiles, License Plate Recognition (LPR) gate controllers and Consumer products including battery-operated fingerprint and face-reader Door Locks. Our security solutions are multi-lingual and localized in over 18 different languages. At the ZKTeco state-of-the-art 700,000 square foot ISO9001-certified manufacturing facility, we control manufacturing, product design, component assembly, and logistics/shipping, all under one roof.

The founders of ZKTeco have been determined for independent research and development of biometric verification procedures and the productization of biometric verification SDK, which was initially widely applied in PC security and identity authentication fields. With the continuous enhancement of the development and plenty of market applications, the team has gradually constructed an identity authentication ecosystem and smart security ecosystem, which are based on biometric verification techniques. With years of experience in the industrialization of biometric verifications, ZKTeco was officially established in 2007 and now has been one of the globally leading enterprises in the biometric verification industry owning various patents and being selected as the National High-tech Enterprise for 6 consecutive years. Its products are protected by intellectual property rights.

About the Manual

This manual introduces the operations of the Portable Pole Metal Detector MDS100.

All figures displayed are for illustration purposes only. Figures in this manual may not be exactly consistent with the actual products.

Table of Contents

- 1 OVERVIEW 7**
 - 1.1 INTRODUCTION 7**
 - 1.2 APPEARANCE..... 8**
 - 1.3 DIMENSIONS..... 9**
 - 1.4 SPECIFICATIONS 10**
 - 1.5 PERFORMANCE AND TECHNICAL FEATURES 12**
 - 1.6 DETECTION DISTANCE 12**
 - 1.7 COMPONENTS 13**
- 2 INSTALLATION SETUP 14**
 - 2.1 SAFETY PRECAUTIONS..... 14**
 - 2.2 INSTALLATION SITE 14**
 - 2.2.1 MOVABLE METALLIC ITEMS..... 14
 - 2.2.2 FLOOR VIBRATION..... 14
 - 2.2.3 ELECTROMAGNETIC RADIATION AND INTERFERENCE..... 14
 - 2.2.4 INSTALLATION STEPS 15
- 3 DETECTION ZONES 17**
- 4 OPERATIONAL PROCEDURE 18**
 - 4.1 MAIN MENU 18**
 - 4.2 ADJUSTING SENSITIVITY 20**
 - 4.3 SECURITY LEVEL SETTING..... 20**
 - 4.4 APPLICATION AREA SETTING..... 22**
 - 4.5 ALARM SETTINGS 22**

- 4.6 AUTOTEST 24**
- 4.7 SYSTEM PASSWORD 26**
- 4.8 RECORD QUERY 26**
- 4.9 SYSTEM SETTINGS..... 27**
 - 4.9.1 SLEEP MODE..... 28
 - 4.9.2 TIME SETTINGS 29
 - 4.9.3 LANGUAGE 29
 - 4.9.4 RESET..... 30
- 4.10 SYSTEM INFO 31**
- PACKING LIST..... 32**

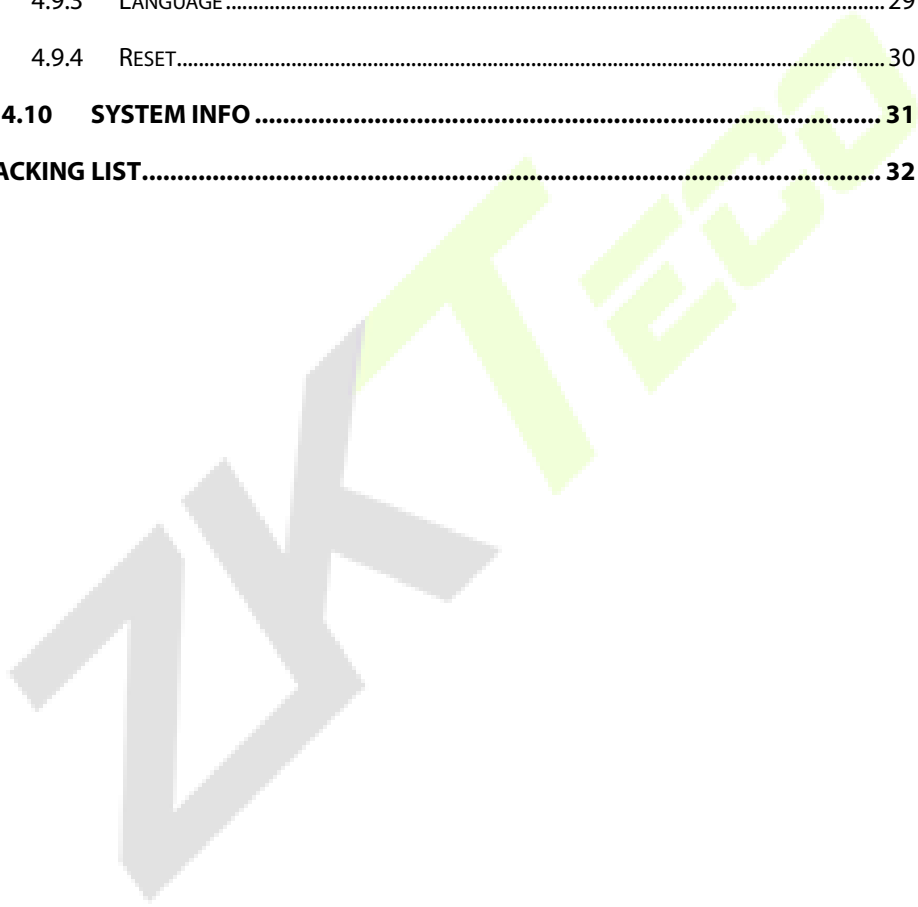

1 Overview

1.1 Introduction

MDS 100 is a metal detection pole that offers a checkpoint specific solution to airports, bus terminals, conferences, customs, docks, and railway stations. *MDS 100* can detect concealed metal objects, smartphones, and smartwatches on a person's body. Its sensitive detection and huge screening capacity outperform the hand-held metal detectors.



1.2 Appearance



1.3 Dimensions

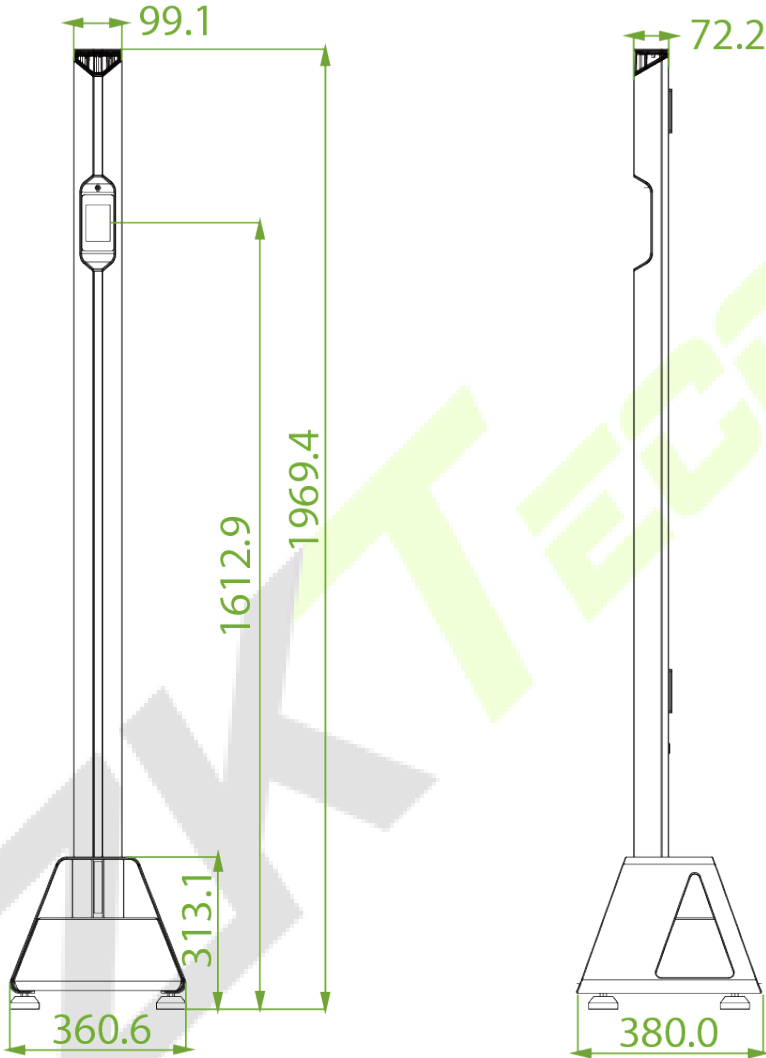

1.4 Specifications

Feature	Descriptions
Maximum Detection Distance	120cm
Detection Radius	Up to 80cm
Throughput Rate	50 people/minute
Sensitivity Level	100
Alarm Zone	2 zones
Touch Screen Size	3.5inches
Alarm Volume	1 to 10 Levels
Alarm Ring	6 Types (selectable)
Input Voltage	15V
Embedded Rechargeable Battery	8Hrs to be fully charged Supports 28Hrs of operation
Battery Capacity	10000mAh
Input Voltage	15V
Operating Current	260mA
Operating Power	3.9W
Housing Material	Aluminum Alloy
Protection Level	IPX5

Operating Temperature	-10°C to 50°C
Storage Temperature	-35°C to 70°C
Operating Humidity	0%RH to 95%RH (non-condensing)
Dimension(L*W*H)	360.6*380.0*1969.4(mm)
Dimension with Packing(L*W*H)	470*545*2380(mm)
Net Weight	15kg
Weight with Packing	40kg
Certification(s)	CE FCC



1.5 Performance and Technical Features

Adjustable Sensitivity: Each detection zone has 100 sensitivity levels (0 to 100). You can preset the metal size, by excluding coins, keys, jewelry, belt buckle, etc.

Digital Pulse Technology: Digital signal processing and filtering system in the detector has an excellent anti-interference ability.

Harmless: With no radiation emitted, the detector is safe for pregnant women, people who implanted pacemakers.

Easy to install: The detector has an integrated design which makes it easy to assemble and disassemble.

1.6 Detection Distance

Since different objects have different lengths, volumes, masses, densities, etc., the detection distance for each different object is also different. Please refer to the actual detection location for the detection distance.

Object	Distance
Keys	30cm
USB flash drive	45cm
Smartwatch	60cm
Utility knife	70cm
Smartphone	80cm
Screwdriver	120cm

1.7 Components

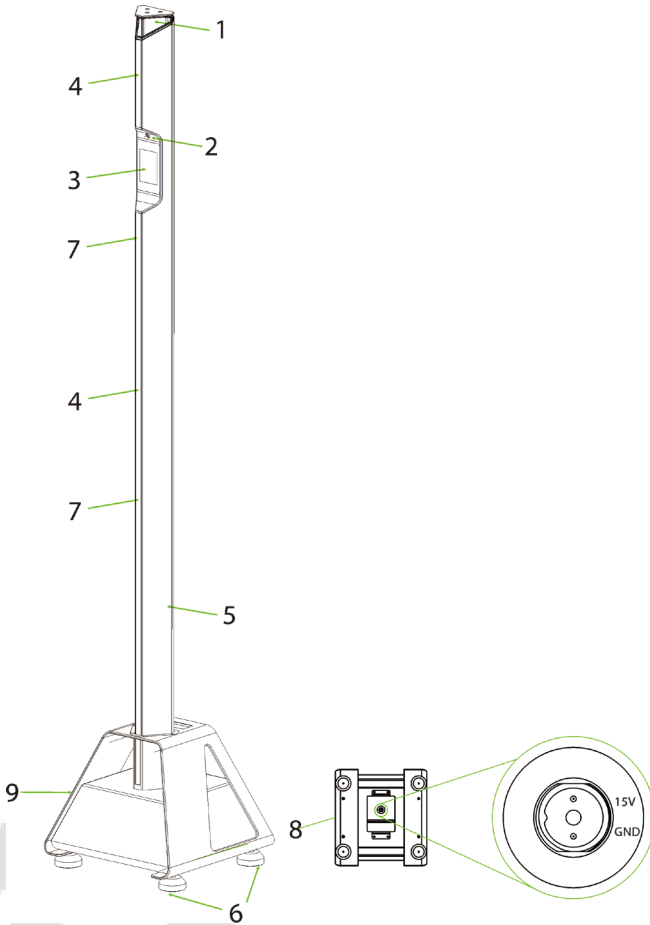

1. Indicator	2. Speaker	3. 3.5-inch Touch Screen
4. Alarm Zone LED	5. Power Button	6. Foot Cup
7. Magnetic Sensor	8. Power Interface	9. Base

2 Installation Setup

2.1 Safety Precautions

- Install the detector on a stable and smooth area. Make sure that the detector is installed firmly on the selected area.
- It can be used for both indoor and outdoor operations.
- Wait for the detector to be calibrated for 2 seconds when it starts initially. Do not touch the detector during a security check to avoid false alarm.
- Do not disassemble the unit without the guidance of a professional technician.

2.2 Installation Site

The following section describes the requirements of the installation environment.

2.2.1 Movable Metallic Items

The movable metallic objects must be kept away at 2 meters from the detector to avoid false alarms.

2.2.2 Floor Vibration

The installation floor must be flat and fixed to avoid false alarm raised from the movement of the people walking through the detector.

2.2.3 Electromagnetic Radiation and Interference

Since the detector uses Bilateral receiver technology, the detector must be installed away at a distance of at least 1 meter from the sources of electromagnetic radiation or electromagnetic interference. The parameters that define the distance are determined by the installation environment and the parameters vary for different installation environments.

The sources of electromagnetic radiation and electromagnetic interference are given below:

Electrical Control Box, Radio frequency equipment, Interphone, High Power Motor, Power Transformer, AC Power Lines, Thyristor Control Circuit (High Power Switching Power Supply, Inverter Welder), Engine, Motor, etc.

2.2.4 Installation Steps

Make sure that the device is installed as per the following installation instructions. If you want to open the chassis, you should contact the agent for permission. Otherwise, you will bear any consequence resulting from your actions.

- Install on the base

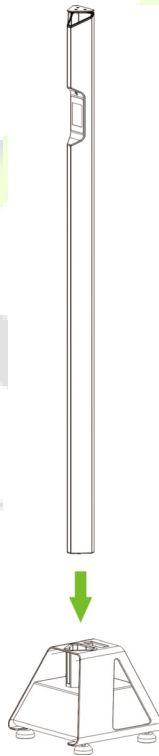

Insert the pole into the hexagonal slot of the base.

- Install on the wall

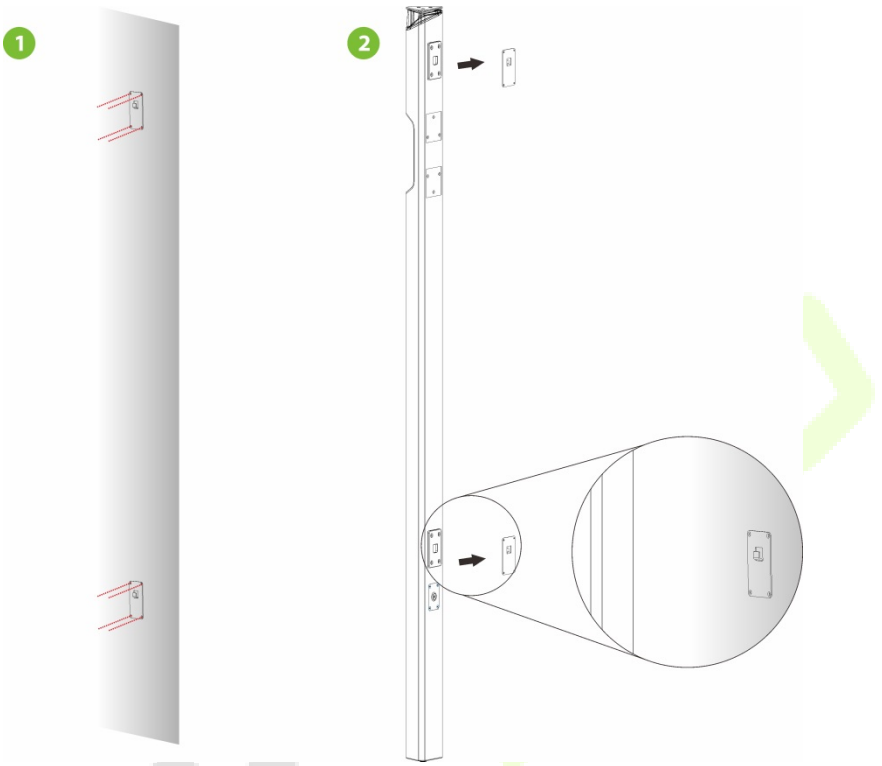

1. Fix the back plates on the wall according to the pole position using wall mounting screws;
2. Attach the pole to the back plates.

Note: The detector's sensor needs to point to the North Pole.

3 Detection Zones

The MDS100 detector can detect a wide range of threat objects/weapons composed of magnetic.

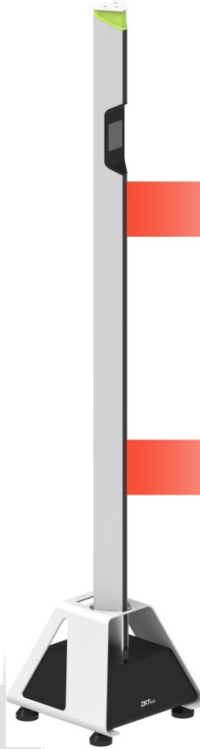

The two detection zones and accurate detection ensures that if the metal composition reaches or exceeds the preset value, the alarm LED of the specific zone where the material is hidden will glow and an alarm will be triggered.

4 Operational Procedure

Connect the power supply to the detector. Press the power button, and after 2 seconds of initialization, you can perform the following operations.

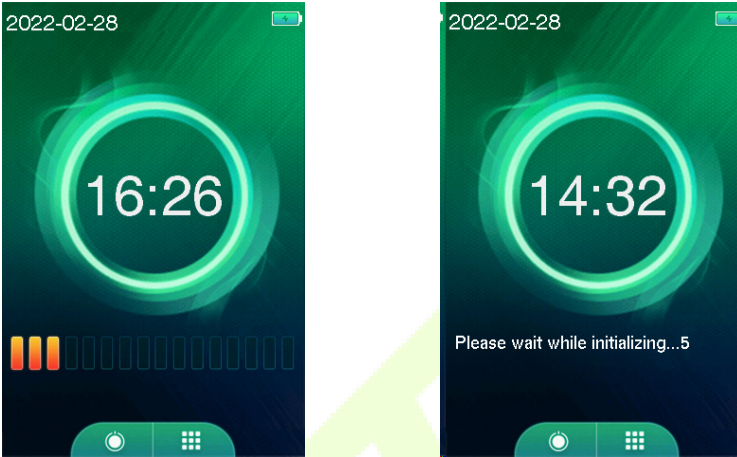

4.1 Main Menu

Press  on the home screen to open the main menu, as shown below:

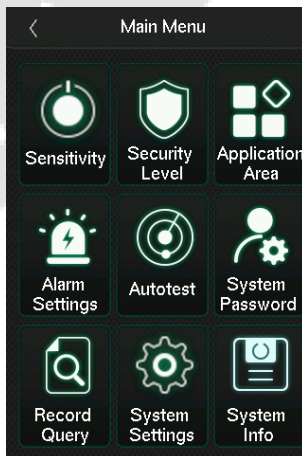

Item	Descriptions
Sensitivity	There are two zones, to set the sensitivity of detection. The larger the value, the more sensitive the system would be, i.e. if a larger value is set, the probe zone is much easier and frequently triggered. The valid value ranges from 1 to 100.
Security Level	Sets the metal detection level. The level can be set to different security levels according to different application area. There are three modes: " High ", " Medium ", and " Low ". It is recommended to use the default level of " Medium ".
Application Area	You can set the usage area as per your requirements such as airports, customs, docks, prisons, train stations and bus stations.
Alarm Settings	To set the volume, alarm count and tone of the alarm.
Autotest	To automatically test whether each module functions properly, including the Zone, LED and Speaker.
System Password	To set the password for data security.
Record Query	When a person passes through the metal detection pole, the corresponding details will be saved in the device. This function allows the user to check the detection records.
System Settings	You may customize the sleep mode, system time, language settings and reset the device.

System Info	You can view the device name, serial number, MAC address, firmware and manufacturer information.
--------------------	--

4.2 Adjusting Sensitivity

There are two zones, to set the sensitivity of detection. The larger the value, the more sensitive the system would be.

Click **Sensitivity** on the main menu.

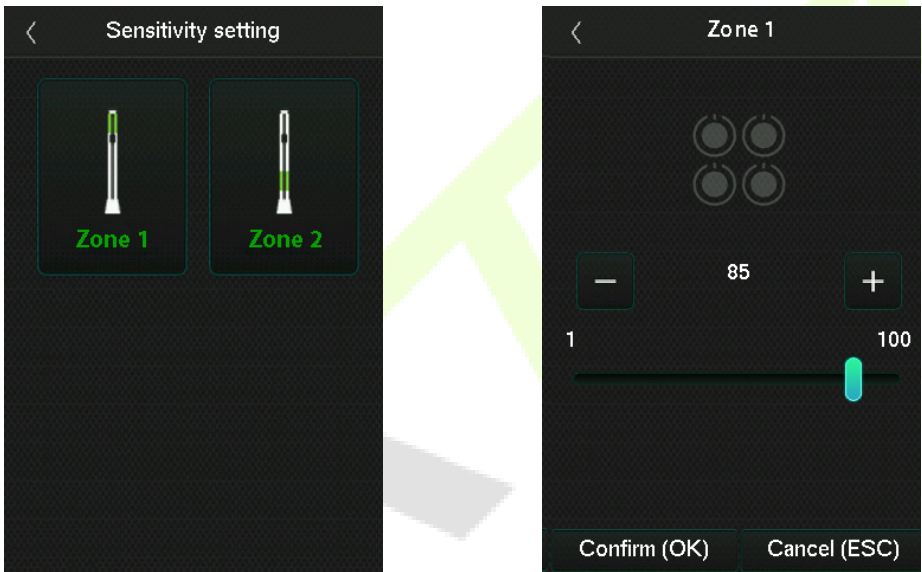



Select the zone to be adjusted, adjust the sensitivity of the zone in the zone interface, and click **OK** to save.

4.3 Security Level Setting

Here, the metal detection level can be set to different security levels according to the real-time application area.

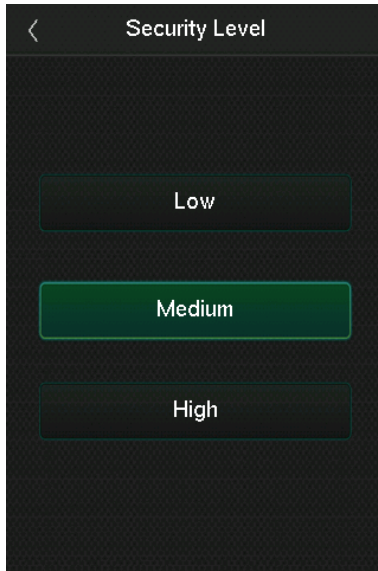
Click **Security Level** on the main menu to set the metal detection level.





Select the security level according to your needs, and the settings will take effect automatically. Press the  icon in the top left corner of the interface to exit the security level interface.

4.4 Application Area Setting

The settings can be selected for security inspections at access points at airports, customs, docks, prisons, train stations, and bus stations.

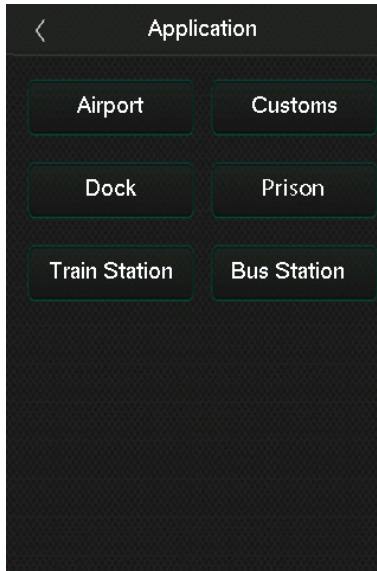
Click **Application Area** on the main menu.



Select the application area according to the requirements and the settings will be updated automatically. Press the  icon in the top left corner of the interface to exit the domain interface.

4.5 Alarm Settings

The Alarm Settings are used to set the volume, alarm count and tone of the alarm.

Click **Alarm Settings** on the main menu.

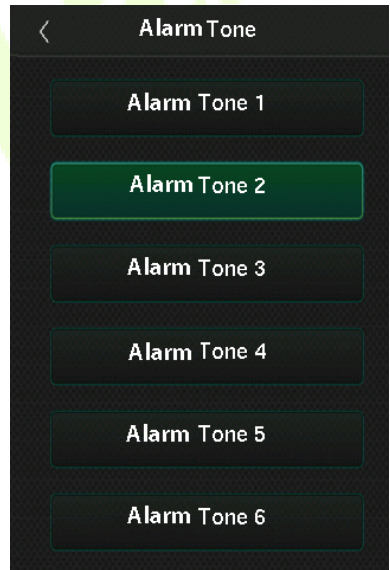
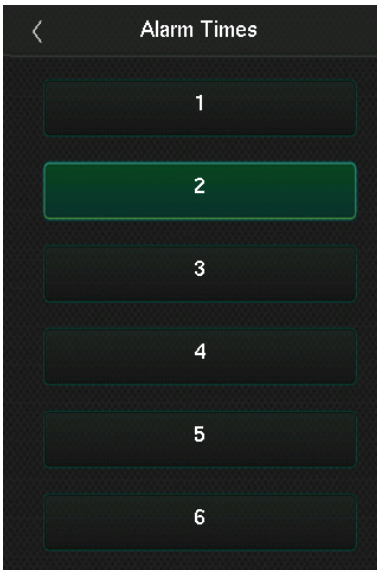
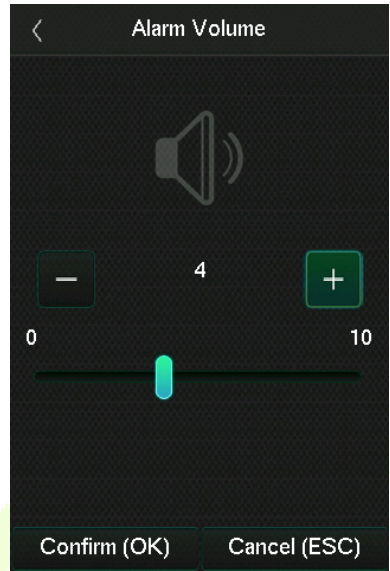
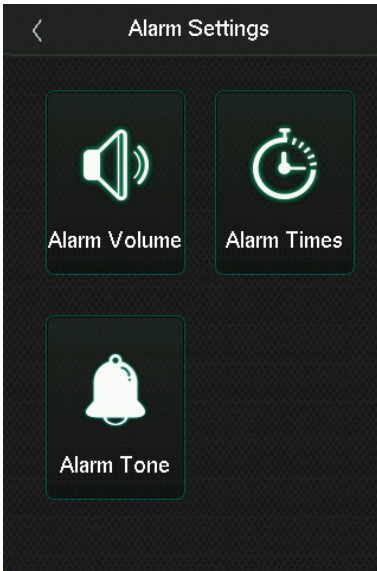

Menu	Descriptions
Alarm Volume	You can adjust the volume of the device; the valid rang is: 0 to 10.
Alarm Times	Set the times of alarms when the metal composition reaches or exceeds the preset value.(The default value is 2)
Alarm Tone	Select an alarm tone from the available options.

4.6 Autotest

The Autotest option is used to automatically test whether each module functions properly, including Zone, LED, and Speaker.

Click **Autotest** on the main menu.

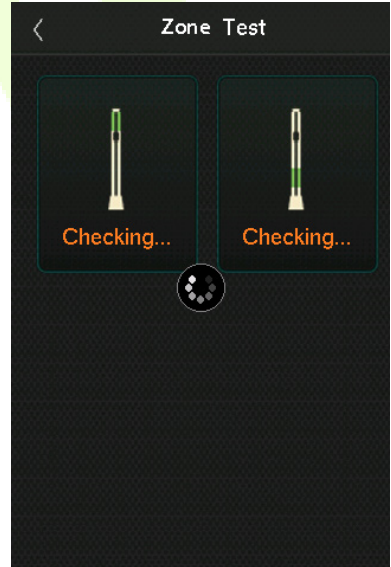
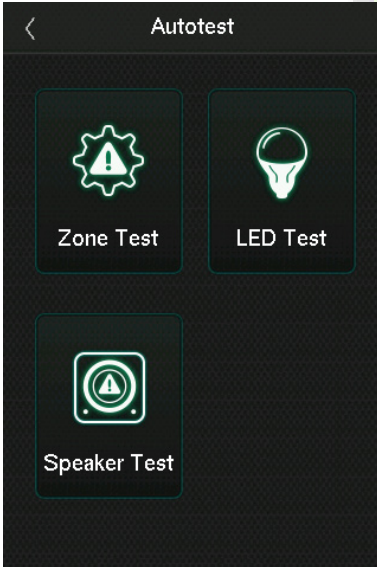

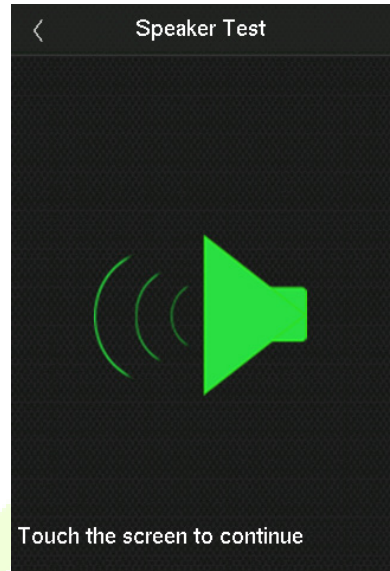
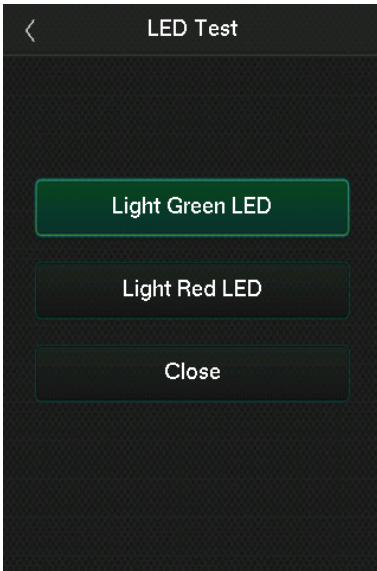

Menu	Descriptions
Zone Test	Check the detector by placing metal in the zone to check whether the detector is sensitive. When a metal is placed in the zone, the detector will alarm.
LED Test	Automatically tests whether the Red and Green LED indicators light up.
Speaker Test	To automatically test whether the audio files stored in the device are complete and the voice quality is good.

4.7 System Password

The System Password feature is used to improve the security of data.

Click **System Password** on the main menu.

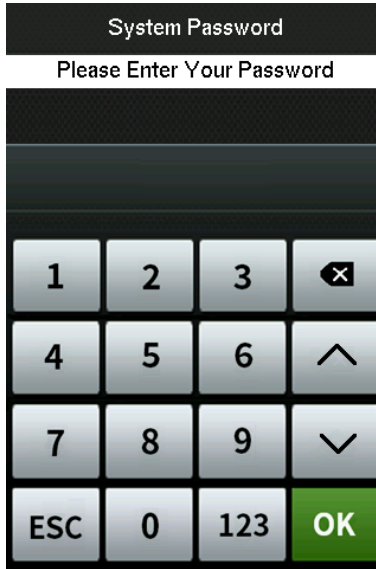

Enter a password and re-enter it. Click **OK**. If the two entered passwords are different, the prompt "Password not match" will appear. The default password is 0, which can be changed, the password may contain 1 to 6 digits.

4.8 Record Query

When a person passes through the detector, the details will be saved in the device. This function allows the user to search for a detection record.

Click **Record Query** on the main menu.

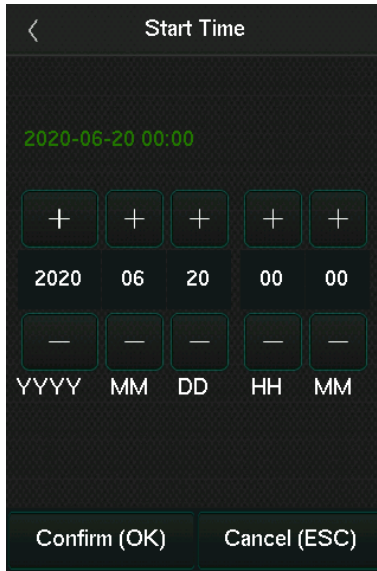

Select the time range you want to search records; press **OK**, the system will search and display the respective record.

4.9 System Settings

You may customize the screen sleep, time, language and reset the device.

Click **System Settings** on the main menu.

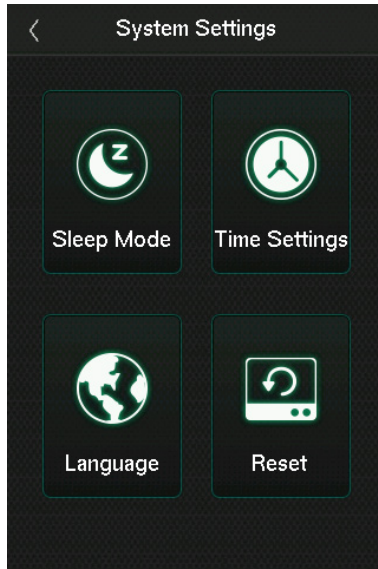

4.9.1 Sleep Mode

Click **Sleep Mode** on the System Settings interface.

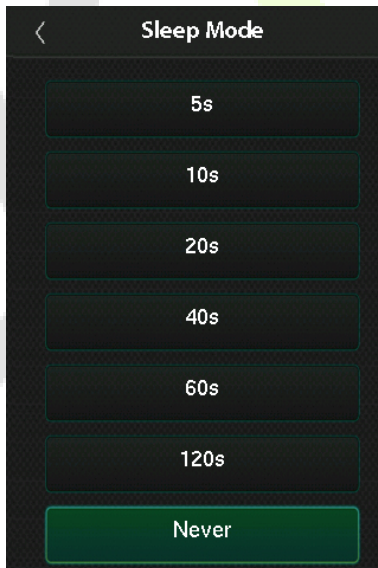

If you have activated the sleep mode, when there is no operation, the device will enter the standby mode. Press any key or finger to resume the normal working mode. You can disable this function or set the value to 5s, 10s, 20s, 40s, 60s or 120s.

4.9.2 Time Settings

Click **Time Settings** on the System Settings interface.

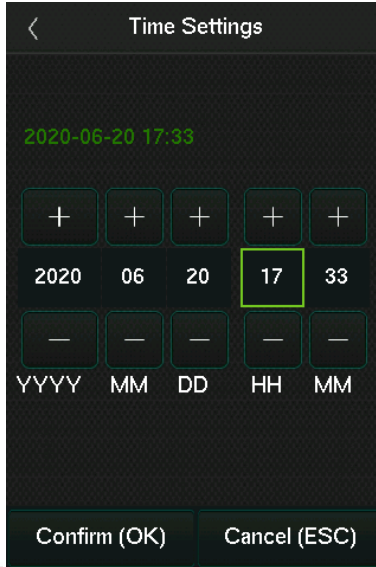

You can manually set date and time and click **Confirm** to save.

4.9.3 Language

Click **Language** on the System Settings interface to select the language of the device.



To select the language of the device.

4.9.4 Reset

Click **Reset** on the System Settings interface.

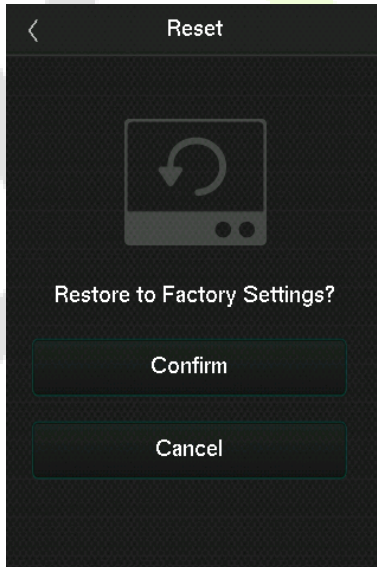

This option restores the device settings, such as system settings, to factory settings (does not clear the data).

Click **OK** to reset.

4.10 System Info

Click **System Info** on the main menu.



Here, you can view the device name, serial number, MAC address, firmware, manufacturer and MCU version information.

Packing List

The package consists of the following items:

S.No	Component	Quantity
1	Pole	1
2	Base	1
3	Plates	2
4	Screw	8
5	Plastic Plug	8
6	User Manual	1
7	Adapter	1
8	Power Cord	1

ZKTeco Industrial Park, No. 32, Industrial Road,
Tangxia Town, Dongguan, China.

Phone : +86 769 - 82109991

Fax : +86 755 - 89602394

www.zkteco.com

